

TEMA

Technologies
Engineering
Materials
Architecture

Journal Director: R. Gulli

e-ISSN 2421-4574

Vol. 7, No. 2 (2021)

Issue edited by Editor in Chief: R. Gulli

Cover illustration: Antonio Pitter power plant, interior view (Malnisio). © Francesco Chinellato, Livio Petriccione, 2019

Editorial Assistants: C. Mazzoli, D. Prati



e-ISSN 2421-4574

Vol. 7, No. 2 (2021)

Year 2021 (Issues per year: 2)

Editor in chief

Riccardo Gulli, Università di Bologna

Assistant Editors

Annarita Ferrante – Università di Bologna

Enrico Quagliarini – Università Politecnica delle Marche

Giuseppe Margani – Università degli Studi di Catania

Fabio Fatiguso – Università Politecnica di Bari

Rossano Albatici – Università di Trento

Special Editors

Luca Guardigli – Università di Bologna

Emanuele Zamperini – Università degli Studi di Firenze

Associated Editors

Ihsan Engin Bal, Hanze University of Applied Sciences – Groningen

Antonio Becchi, Max Planck Institute – Berlin

Maurizio Brocato, Paris – Malaquais School of Architecture

Marco D’Orazio, Università Politecnica delle Marche

Enrico Dassori, Università di Genova

Vasco Peixoto de Freitas, Universidade do Porto – FEUP

Stefano Della Torre, Politecnico di Milano

Marina Fumo, Università di Napoli Federico II

José Luis Gonzalez, UPC – Barcellona

Francisco Javier Neila Gonzalez, UPM Madrid

Alberto Grimoldi, Politecnico di Milano

Antonella Guida, Università della Basilicata

Santiago Huerta, ETS – Madrid

Richard Hyde, University of Sydney

Tullia Iori, Università di Roma Tor Vergata

Raffaella Lione, Università di Messina

John Richard Littlewood, Cardiff School of Art & Design

Camilla Mileto, Universidad Politecnica de Valencia UPV – Valencia

Renato Morganti, Università dell’Aquila

Francesco Polverino, Università di Napoli Federico II

Antonello Sanna, Università di Cagliari

Matheos Santamouris, University of Athens

Enrico Sicignano, Università di Salerno

Claudio Varagnoli, Università di Pescara

Editorial Assistants

Cecilia Mazzoli, Università di Bologna

Davide Prati, Università di Bologna

Journal director

Riccardo Gulli, Università di Bologna

Scientific Society Partner:

Ar.Tec. Associazione Scientifica per la Promozione dei Rapporti tra Architettura e Tecniche per l’Edilizia

c/o DA - Dipartimento di Architettura, Università degli Studi di Bologna

Viale del Risorgimento, 2

40136 Bologna - Italy

Phone: +39 051 2093155

Email: info@artecweb.org - tema@artecweb.org

Media Partner:

Edicom Edizioni

Via I Maggio 117

34074 Monfalcone (GO) - Italy

Phone: +39 0481 484488

TEMA: Technologies Engineering Materials Architecture**Vol. 7, No. 2 (2021)**

e-ISSN 2421-4574

Editorial**New Horizons for Sustainable Architecture***Vincenzo Sapienza*

DOI: 10.30682/tema0702a

5

CONSTRUCTION HISTORY AND PRESERVATION**Retrofitting detention buildings of historical-cultural interest. A case study in Italy***Silvia Pennisi*

DOI: 10.30682/tema0702b

7

Digital georeferenced archives: analysis and mapping of residential construction in Bologna in the second half of the twentieth century*Anna Chiara Benedetti, Carlo Costantino, Riccardo Gulli*

DOI: 10.30682/tema0702c

17

A novel seismic vulnerability assessment of masonry façades: framing and validation on Caldarola case study after 2016 Central Italy Earthquake*Letizia Bernabei, Generoso Vaiano, Federica Rosso, Giovanni Mochi*

DOI: 10.30682/tema0702d

28

Italian temporary prefabricated constructions (1933-1949). Projects, Patents and Prototypes*Laura Greco*

DOI: 10.30682/tema0702e

42

Relationship between building type and construction technologies in the first Friuli Venezia Giulia hydroelectric plants*Livio Petriccione, Francesco Chinellato, Giorgio Croatto, Umberto Turrini and Angelo Bertolazzi*

DOI: 10.30682/tema0702f

54

CONSTRUCTION AND BUILDING PERFORMANCE**Straw in the retrofitting existing buildings: surveys and prospects***Beatrice Piccirillo, Elena Montacchini, Angela Lacirignola, Maria Cristina Azzolino*

DOI: 10.30682/tema0702g

70

Digital models for decision support in the field of energy improvement of university buildings <i>Cristina Cecchini, Marco Morandotti</i> DOI: 10.30682/tema0702h	80
Setting an effective User Reporting procedure to assess the building performance <i>Valentino Sangiorgio</i> DOI: 10.30682/tema0702i	90
The synthetic thermal insulation production chain – moving towards a circular model and a BIM management <i>Ornella Fiandaca, Alessandra Cernaro</i> DOI: 10.30682/tema0702l	105
BUILDING AND DESIGN TECHNOLOGIES	
Automated semantic and syntactic BIM Data Validation using Visual Programming Language <i>Andrea Barbero, Riccardo Vergari, Francesca Maria Ugliotti, Matteo Del Giudice, Anna Osello, Fabio Manzone</i> DOI: 10.30682/tema0702m	122
How do visitors perceive the Architectural Heritage? Eye-tracking technologies to promote sustainable fruition of an artistic-valued hypogeum <i>Gabriele Bernardini, Benedetta Gregorini, Enrico Quagliarini, Marco D’Orazio</i> DOI: 10.30682/tema0702n	134
An eco-sustainable parametric design process of bio-based polymers temporary structures <i>Cecilia Mazzoli, Davide Prati, Marta Bonci</i> DOI: 10.30682/tema0702o	145

STRAW IN RETROFITTING EXISTING BUILDINGS: SURVEYS AND RESEARCH PERSPECTIVES



e-ISSN 2421-4574
Vol. 7, No. 2 - (2021)

Beatrice Piccirillo, Elena Montacchini, Angela Lacirignola,
Maria Cristina Azzolino

DOI: 10.30682/tema0702g

Highlights

Is it possible to use straw in Italy not only for new constructions but also for existing buildings retrofit?
Technological analyses, direct surveys, and on-site measurements allow highlighting the strengths and weaknesses of using straw in construction. So, possible development scenarios are identified to promote the use of straw as an alternative for the energetic upgrade of the existing building heritage.

Abstract

The article aims to investigate the feasibility of straw as an alternative to traditional construction materials, with particular reference to the retrofit of buildings. This paper is part of the international debate on environmental sustainability, energy efficiency, and rehabilitation of the existing building heritage and reports the results of research carried out at the Department of Architecture and Design of the Politecnico di Torino. After initial research and classification of the main construction techniques that can be used to realize straw thermal coats, a survey was started to collect opinions on the use of straw in construction from professionals and potential users. At the same time, one on-site measurement campaign was carried out to assess the thermal transmittance of the straw insulation coat. The different investigations – literature research, surveys, experimentation – highlighted the strengths and weaknesses of the use of straw and identified possible scenarios for its wider application in Italy.

Keywords

Building retrofit, Thermal insulation coat, Straw, Direct surveys, On-site measurements.

Beatrice Piccirillo*

DAD - Dipartimento di Architettura e Design, Politecnico di Torino, Torino (Italy)

Elena Montacchini

DAD - Dipartimento di Architettura e Design, Politecnico di Torino, Torino (Italy)

Angela Lacirignola

DAD - Dipartimento di Architettura e Design, Politecnico di Torino, Torino (Italy)

Maria Cristina Azzolino

DAD - Dipartimento di Architettura e Design, Politecnico di Torino, Torino (Italy)

* Corresponding author:
e-mail: beatrice.piccirillo@studenti.polito.it

1. INTRODUCTION

The construction sector, and the residential sector in particular, massively contributes to the environmental impact. It is responsible for 30% of energy consumption and 28% of CO₂ emissions worldwide [1]. In Italy, this scenario is accentuated due to the characteristics of the existing building heritage, poor energy efficiency due

to the age of the buildings, and the construction techniques used. Thermal bridges in structural nodes and dispersions from the envelope, doors, and windows lead to high annual energy losses to provide internal comfort conditions [2]. Renovation works are mainly focused on the building's envelope, allowing the reduction of energy

requirements by 30-50% by increasing the thermal insulation performance alone [1].

This situation encourages the research of new technologically and energetically efficient solutions for the upgrading of the casing. Which role could be played by natural materials within this context? Is it possible to use straw as a sustainable alternative to traditional building materials for the envelope's insulation?

The research was carried out to answer these questions. It began with a master's degree thesis developed with the assistance of professors and technicians from the technological area of the Department of Architecture and Design of the Politecnico di Torino [3]. Specifically, the Innovative technological systems laboratory (LaS-TIn) and analysis and modelling of environmental system laboratory (LAMSA) were involved.

2. RESEARCH METHOD AND AIMS

This paper aims to assess the feasibility of straw in building retrofit in Italy, with particular reference to Northern Italy, and to investigate its potential and shortcomings.

The research started from a first classification of the main techniques used for the construction of straw insulation coats in the upgrading of the building envelope to assess aspects related to technical and site feasibility.

In this phase, theoretical research on publications, manuals, and technical documentation was combined with a collection of retrofitting projects in Europe and Northern Italy.

The catalog of the case studies allowed examining, mainly through images of the building sites, the building techniques involved and to relate them to the context, the resources, and the aesthetic and performance goals.

Following the initial analysis of techniques, surveys were carried out in the form of online questionnaires and direct interviews.

The surveys were addressed to potential users in order to assess their general level of knowledge about straw constructions and their will to use straw in architecture.

The involvement of specialized people in construction for the survey field has also allowed the evaluation of technical aspects and site feasibility.

Three different surveys for three different target groups were prepared: unspecialized figures, professionals, and specialized professionals. The unspecialized figures are people with no technical training who approach architecture as users or clients. Professionals are engineers, architects, and surveyors who do not usually use straw in their job. Specialized professionals are those who regularly use straw in their projects.

Furthermore, a recent retrofit project was used as a case study to assess the behavior of straw concerning its thermal transmittance.

3. STRAW BALE INSULATION COATS: TECHNOLOGICAL SOLUTIONS

Straw has been used in construction for over a century now. The first buildings to feature its use are located on the plains of the central United States and date back to 1890. At that time, with the invention of the baling machine, loose straw was transformed into bales and used to make perimeter walls, sometimes with a load-bearing function too.

Initially, only temporary constructions had built using straw, which was more available and cheaper than other valuable resources such as wood and stone. As time went by, it became clear that straw was efficient in terms of environmental comfort, both in summer and winter, and began to be used to build permanent housing, of which there is still evidence to this day [4].

More recently, with the refinement of construction techniques on the one hand and the growing need to increase the energy efficiency of the building heritage on the other, the practice of using straw not only in new constructions but also to upgrade existing buildings has become increasingly widespread.

The research focused on the techniques used to create the external coats and investigated the various installation methods and technological details, analyzing case studies both in Italy and elsewhere.

The construction techniques originate from those used to build buffer walls and can be traced back to two types of installation, depending on whether or not wooden frames are used.

The first laying method involves anchoring vertical wooden planks to the existing wall using metal brackets

to create a frame in which the straw bales will be stacked. Approximately every three layers, the straw must be compressed. A pair of hydraulic jacks and a horizontal wooden plank are usually used for this. Once the plank has been pressed down to the required level, it is secured to the vertical uprights to keep the bales in shape [5].

In the second case, the bales are staggered as they are stacked and connected through thin vertical wooden or metal elements [6]. The first layers are stacked on steel rods anchored directly to the base ring beam to stabilize the stacking surface. Each subsequent layer will be connected to the previous ones by square or circular wooden stakes or metal bars. The bales are anchored to the wall behind them using plastic or metal ties, and, in this case, too, they must be held in compression (Fig. 1).

Whichever technique is chosen, the details to be given particular attention are the ground connection, the roof, and the windows.

As with any other straw wall, a straw coat must be protected from water and humidity too. Contact with the ground and with splashing or rising water should be avoided. Consequently, up to a height of at least 30 cm, a base or a splash boarding have to be provided, and special attention must be paid to waterproofing operations. The base can be built from several different materials (e.g., brick, standard or cellular concrete, cellular glass) and can be a compact base or contain loose insulating material such as expanded clay. Depending on the type of soil, it can be extended below ground level, becoming a real foundation for the coat [6].

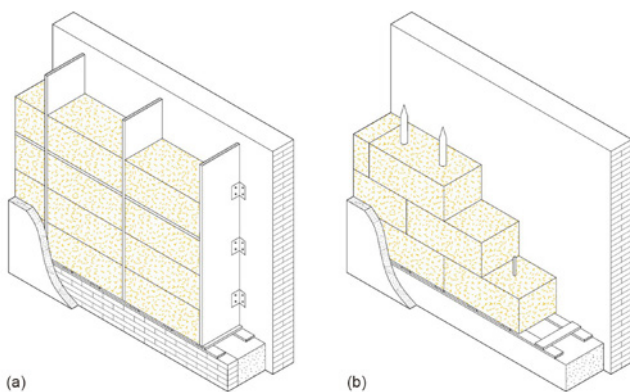

Fig. 1. Construction techniques with wooden frames (a) and without wooden frames (b).

If the building retrofitting does not include the renovation of the roof, where the existing roof does not guarantee appropriate coverage of the new thermal insulation, the roof pitches must be extended, or additional roofing systems must be provided.

Regarding the windows, straw bale's thickness could reduce the incoming light into the interior. To solve this problem, if it is not possible to move the position of the window frames outwards, alternative design solutions can be involved, such as frames flared outwards. Particular attention should also be paid to water and air tightness, to thermal bridges near the thresholds, and to the connection with any external shading and screening systems.

Once the coat is finished, the surface is protected with plaster, applied directly to the previously shaved straw or a plaster mesh, or with the covering and finishing material that best suits the image desired for the building.

The analysis of the case studies catalog confirms the construction techniques mainly used and highlights the characteristics of the construction sites.

These are “artisanal” construction sites, mostly located in slightly urbanized environments.

The material shows characteristics of manageability and speed of installation. In fact, the weight and size of the straw bales make it possible to create large surfaces with a reduced number of elements.

These characteristics of the material allow the intervention to be carried out also in self-building, but the design and management of the construction site must be entrusted to an expert to avoid errors that would cancel out the effectiveness of the system.

The absence of standardized products and operations is one of the weaknesses. As a result, some companies are moving towards the development of engineered technological systems that make it possible to arrive on-site with prefabricated elements that make the site faster, cleaner, and standardized.

4. QUESTIONNAIRES AND INTERVIEWS

The opinion of potential users and professionals was sought to assess the general level of knowledge about straw construction and its technical and construction feasibility aspects.

The survey was carried out in October–December 2019. Two survey tools were chosen: an online questionnaire through Google Modules made up of closed-answer questions and a direct interview with open-answer questions. The first was submitted via e-mail and social media to people with no specialization in the field of architecture and to professionals who do not normally use straw in their projects. The direct interview, on the other hand, was submitted to specialized professionals in straw construction.

4.1. THE VIEWPOINT OF UNSPECIALIZED PEOPLE

The online questionnaire “Straw in architecture” was answered by 257 people. The sample is predominantly in the 40–65 age group and lives in the North of Italy.

The survey was divided into four sections:

- the first aimed at getting to know the respondent’s profile;
- the second aimed at understanding whether the respondent was informed on straw constructions;
- the third aimed at assessing the respondent’s willingness to build their own house using straw and their doubts about this material;
- the last section aimed at measuring the respondent’s sensitivity towards topics such as the environment and ecological and energetic sustainability.

The questionnaire reveals that respondents have much misinformation. Most of them say that they have already heard about straw constructions (despite feeling that they are not sufficiently informed), but there are still some misconceptions and prejudices about its use as a construction material. The main prejudices relate to flammability, perishability, and vulnerability to insects and rodents. Respondents also claim to be poorly informed about the possibilities of using straw and do not know whom to entrust design and construction work to. However, a modest number of respondents appear willing to build their homes using straw mainly to reduce the environmental impact of the new building, encouraging the use of new technological systems and alternative materials, and promoting the conscious use of resources (Fig. 2).

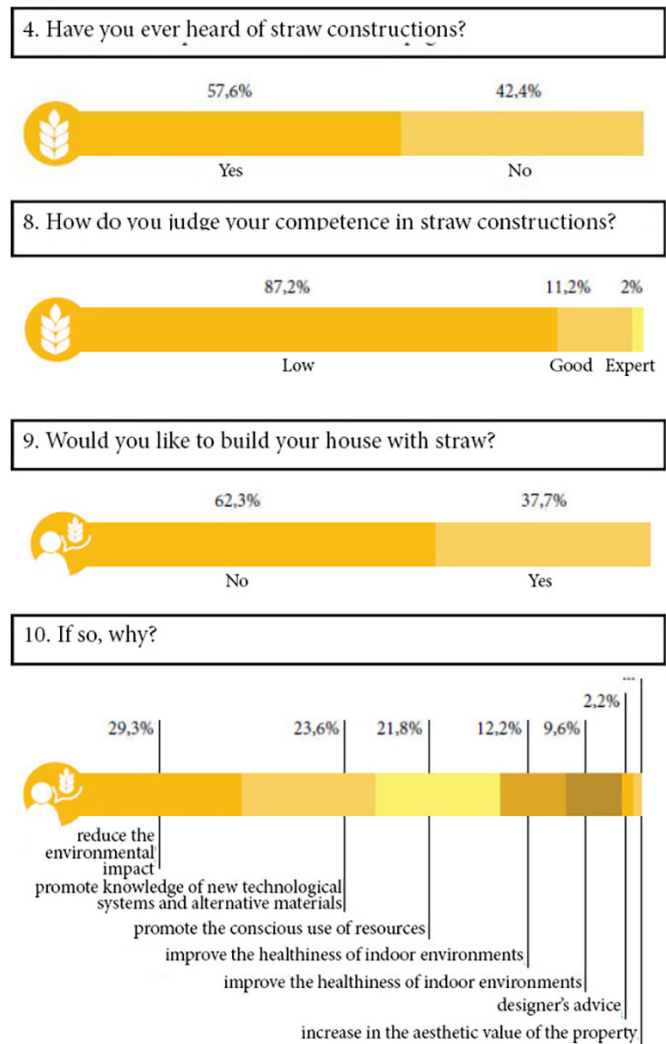

Fig. 2. Extract from the survey for unspecialized people.

4.2. THE VIEWPOINT OF UNSPECIALIZED PROFESSIONALS

This second questionnaire was completed by 31 professionals, including architects, engineers, and surveyors.

The sample is predominantly in the 40–65 age group, and 80% of them work as architects. Most of them have been working in Northern Italy for more than 15 years.

Like the previous one, the questionnaire was organized into four sections, as described below:

- the first section consisted of four questions to outline the *interviewee's profile*;
- the second section, *general knowledge on the subject of straw constructions*, consisted of three questions aimed at finding out the respondent’s level of expertise;
- the third section, *specific knowledge of straw constructions*, consisted of four questions aimed at understand-

ing the respondent’s professional technical skills about design and construction with straw and their interest in and willingness to use it;

- the fourth and final section, *future directions: towards a greener world?*, aimed at understanding professionals’ views on the use of straw in architecture in the future.

The answers show a good level of theoretical knowledge about the performance and technological characteristics of straw buildings and about the case studies. The interviewees declare, however, that they have never applied this construction technique in any of their projects, that they do not have sufficient executive skills, and that they are poorly informed about the availability and supply of straw, the differences between different types of raw materials, the legislation, and the costs (Fig. 3).

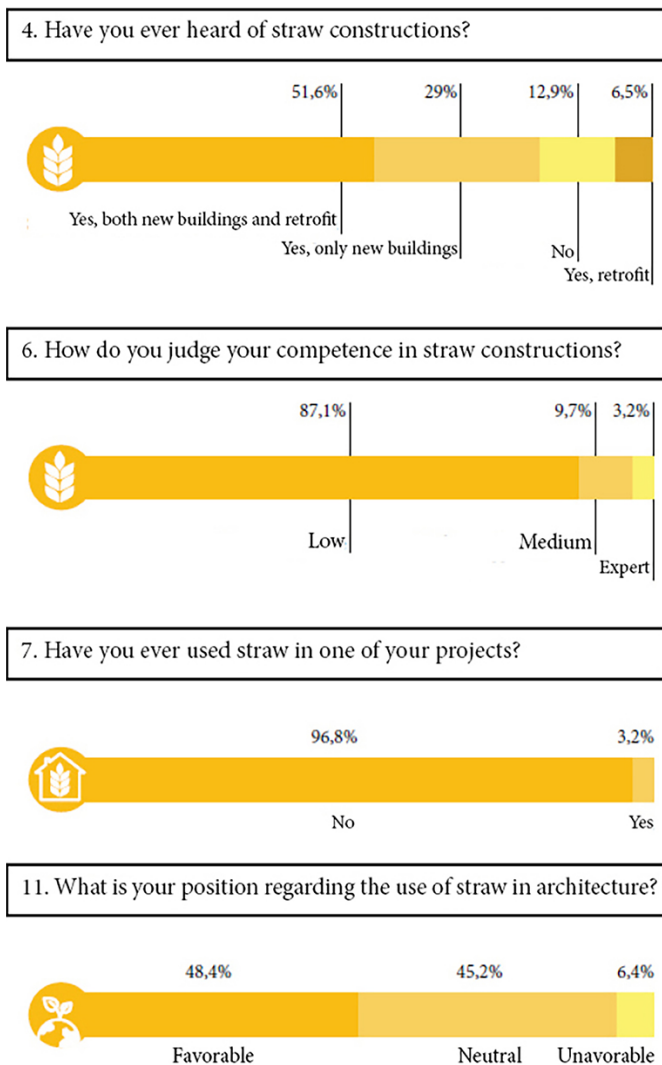

Fig. 3. Extract from the survey for unspecialized professionals.

4.3. THE OPINION OF EXPERTS IN THE SECTOR

The interview, consisting of eleven open-ended questions, was presented to five specialized professionals in straw construction who mainly work in Piedmont.

The interview focused on more general issues, such as the spread of straw in Italy and Europe, but also involved more technical aspects such as construction sites, technological solutions, costs, and energy simulations with specific software.

There is no doubt about the considerable insulating properties of straw and the advantages of its use. Besides providing adequate thermal insulation, the considerable thickness of the bales provides appropriate mass to guarantee an efficient behavior in summer with thermal wave phase shift values close to 12 hours. From a technological point of view, straw is an easily mouldable substrate which, unlike other traditional drywall systems, does not require the use of dowels or glues. It is a lightweight material and therefore easily transportable without the use of mechanical equipment and can be processed using low-energy and low-hazard tools. Straw is usually associated with raw earth plasters because, besides guaranteeing the necessary transpiration, they act as natural hygrometric regulators. The use of straw also brings the economy back to the territory, opening up a new perspective for agriculture, which no longer has to manage a waste material by turning it into an economic income.

However, the interviews highlighted several critical issues:

- Italian regulations are more complex and restrictive than those of other European countries, as Italy is a country with high seismic risk;
- the thermal coat is very thick due to the size of the straw bale, causing several consequences such as the reduction of incoming light;
- the building site requires plenty of space for the storage of the straw bales, which is not always available, especially in an urban environment;
- the shortage of specialized labor implies the use of traditional labor that tends to work according to ‘traditional’ construction site practices, leading to installation errors;

- the lack of a completely dry-execution engineered technological system slows down construction time and increases the chance of error;
- the construction traditions rooted in our country hinder the spread of different construction systems: we are highly accustomed to brick and concrete, and it is not easy to place the same trust in natural materials such as straw;
- the lack of a database with standardized physical and technical parameters leads to arbitrary results of the energy simulation that are hard to compare with each other.

Talking about costs, almost all respondents agreed that the use of straw does not lead to an increase in the overall cost of the work. The lower cost of the raw material balances the higher costs of construction time and labor, which, being specialized, requires a higher salary.

5. EXPERIMENTAL MEASUREMENTS CARRIED OUT ON SITE

From the energy point of view, a measurement campaign was carried out to experimentally assess the performance of a brick building wall to which a straw coat was applied as part of an upgrading project.

The instrumental investigation, which included thermography and thermoflowmetry, made it possible to assess the thermal transmittance on site.

For new construction work, the thermal transmittance of a structure is assessed during the design phase and is calculated using the EN ISO 6946:2018 standard using data taken from technical standards or data sheets of the materials selected.

For interventions on existing buildings, thermal transmittance can always be assessed analytically, referring to data published in the literature or technical reports de-



Fig. 4. Case study.

posited with the municipal administration. Alternatively, instrumental verification can be used with on-site measurement [7, 8], in compliance with ISO 9869:2015.

The detached house in question, located in Alba (CN), was built in the 1960s, at a time when most houses were built with a load-bearing structure in reinforced concrete and vertical buffer walls made of perforated bricks with no thermal insulation (Fig. 4).

Building renovation works carried out between 2017

and 2018 include the realization of a thermal coat made of straw bales on the South-West side and part of the North-East side.

In particular, straw bales with a total thickness of 45 cm and a density value of approximately 130 kg/m³ (data provided by designers). The strawbales were placed in a wooden frame fixed to the existing wall with the fiber perpendicular to the wall and were covered with 2 cm of lime plaster applied on a plaster mesh (Fig. 5).

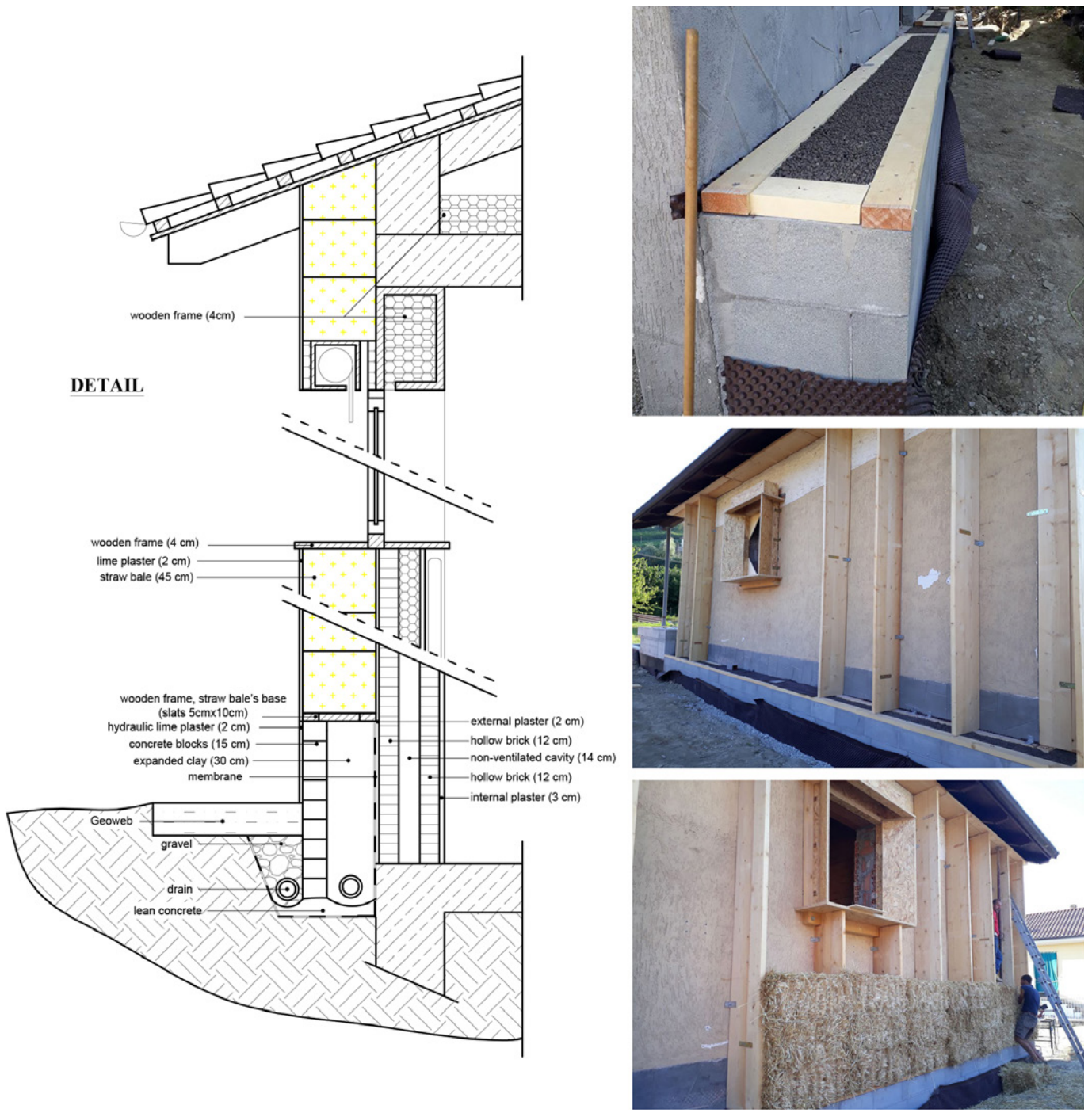

Fig. 5. Wall section detail and a photo of the construction site.

Measurement on site took place from 5/02/2020 to 10/02/2020. The thermo-flowmetric method defined by UNI ISO 9869-1:2015 was used.

A data logger equipped with thermal flux and surface temperature probes was used to assess thermal transmittance of the opaque element, exploiting the Fourier law and measuring heat transfer between the two faces of the wall and inner/outer wall surface temperatures.

The instrumentation necessary (Fig. 6) for the survey was positioned on the North-East wall after carrying out a thermographic survey to check the following conditions (Fig. 7):

- absence of thermal irregularities, such as thermal bridges and heat sources;
- absence of direct exposure to the sun [9].

The instantaneous values were acquired at 10-minute intervals, with a total of 667 acquisitions, in compliance with ISO 8301:1991.

Since achieving steady-state conditions is often cumbersome in the field, data analysis was carried out assuming the mean values of heat flow rate and temperatures obtained with the running average method.

In figure 8, the measured results of heat flux, indoor/outdoor air temperatures, inner/outer wall surface temperatures, conductance, and transmittance are shown as the trend over time and mean values.

Then, based on the thermo-flowmetric data acquired, processed using the moving average method, the experimental thermal transmittance value of $U=0.22 \text{ W/m}^2\text{K}$ was defined and then used to reach a thermal conductivity value λ in the straw, corresponding to 0.13 W/mK .

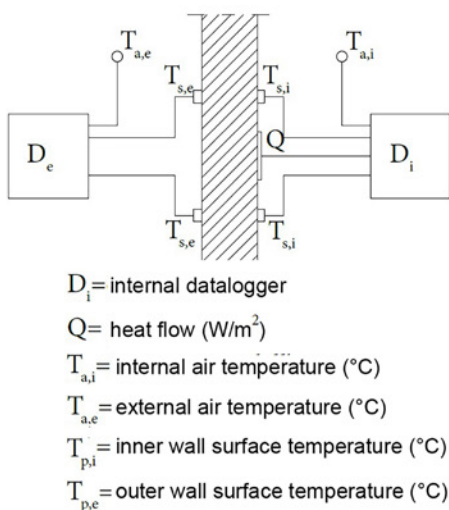

Fig. 6. The instrumentation for measurement.

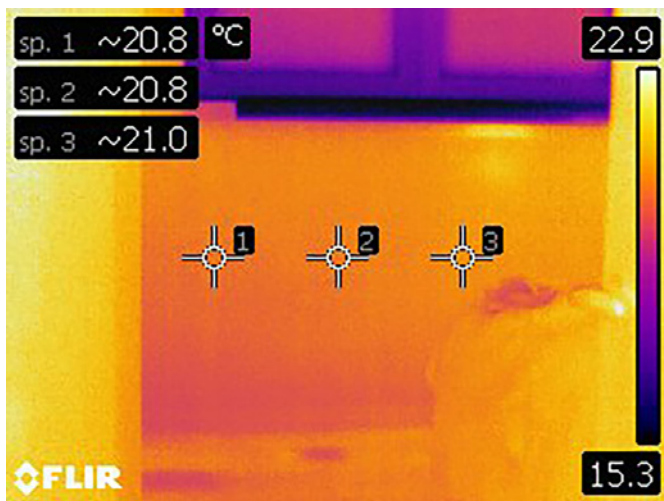

Fig. 7. Thermal image of the wall.



Fig. 8. Graph of the instantaneous heat flow trend $Q \text{ [W/m}^2\text{]}$.

In parallel, the thermal transmittance of the wall was calculated using energy simulation software.

For the strawbale, which was not present in the software database, the values provided by the designers were used, and the missing ones were taken from the literature (Fig. 9) [10, 11].

A thermal conductivity value λ of 0.07 W/mK was used, and the thermal transmittance U was found to be 0.131 W/m²K.

The comparison between the results obtained following the field measurement and those related to the simulation confirms that there is a discrepancy between the values measured and the values calculated, partly due to the lack of unambiguous thermal conductivity values.

In Italy, the lack of technical regulations leads professionals who are preparing to use the straw to rely on physical-technical values from other European countries. Countries such as Austria, Germany, and Denmark have promoted various studies, carried out in compliance with European standards, from which the following thermal conductivity results emerge:

Source	Author	Year	bale position	bale density [kg/m ³]	λ [W/mK]
Jones	McCabe	1993	on flat	133	0,061
Jones	McCabe	1993	on edge	133	0,054
Jones	Sandia Labs	1994	on edge	83	0,054
Jones	ORNL	1996	on flat	n.d.	0,153
Jones	CEC/ATI	1997	on flat	107	0,128
Jones	ORNL	1998	on flat	107	0,1
Jones	Ship Harb.	1995	on flat	128	0,1
Atkinson	Andersen	2004	on flat	75	0,057
Atkinson	Andersen	2004	on edge	75	0,052
Atkinson	Andersen	2004	on flat	90	0,06
Atkinson	Andersen	2004	on edge	90	0,056
Atkinson	Minke e M.	2005	on flat	n.d.	0,06
Atkinson	Minke e M.	2005	on edge	n.d.	0,045
Atkinson	Oliva	2010	on flat	80-120	0,06-0,075
Atkinson	Oliva	2010	on edge	80-121	0,04-0,055
	FASBA	2014	on edge	n.d.	0,052
Mutani, et al.		2019	on flat	62	0,082
Mutani, et al.		2019	on flat	75	0,057
Mutani, et al.		2019	on edge	75	0,052
Mutani, et al.		2019	on edge	81	0,057
Mutani, et al.		2019	not spec.	90	0,05-0,06
Mutani, et al.		2019	on edge	100	0,038
Mutani, et al.		2019	on flat	150	0,06
Mutani, et al.		2019	on edge	150	0,048
Mutani, et al.		2019	not spec.	200	0,06
Mutani, et al.		2019	not spec.	250	0,07
Mutani, et al.		2019	not spec.	300	0,075
Mutani, et al.		2019	not spec.	350	0,08

Fig. 9. Comparison of the thermal conductivity values of straw.

- $\lambda=0.0379$ W/mK for the test carried out in Germany at *Forschungsinstitut für Warmeschutz* [12];
- $\lambda=0.0380$ W/mK for the test carried out in Austria by *GrAT (Gruppe Angepasste Technologie)* [13];
- λ between 0.0520 and 0.0600 W/mK for the test carried out in Denmark by the *Danish Technological Institute* [14].

It is clear that to establish a standard thermal conductivity value for straw bales, it is necessary to promote research involving laboratory measurements and verification, monitoring several case studies.

6. CONCLUSIONS

The different investigations carried out – literature research, surveys, experimentation – confirm the benefits of using straw, both from a technological and an energetic performance point of view.

As far as the technological system is concerned, the installation of a straw coat is supported by consolidated techniques, although still poorly engineered. Straw is a lightweight material that is easy to handle on-site. The use of straw also favors the local economy because the material can be supplied by farmers not far from the construction site and also reduces costs and environmental impact due to transport.

As far as energy performance is concerned, straw offers good thermal insulation in winter and good conditions in summer due to its mass and thermal inertia.

These strengths, however, are also associated with unresolved issues and weaknesses. The use of straw is severely limited by the absence of specific technical regulations, the lack of qualified labor, and widespread misinformation, especially among non-specialists.

In addition to these weaknesses, there are technological and construction site problems such as the large thickness of coats and the difficulty to find enough space to store large amounts of straw. As a consequence, straw is usually used in rural areas and isolated buildings.

All this information made it possible to identify possible actions and scenarios for increased use of straw in building renovations.

Surveys aimed at unspecialized people show an interest in straw buildings intending to reduce envi-

ronmental impact and to promote the conscious use of resources. This interest is hampered by a lack of knowledge and difficulty in finding information on the feasibility and durability of the material. Consequently, the promotion of knowledge of this building technique through various channels such as the web, TV and events, training sessions, workshops, and seminars, open to everyone, could be key to raising awareness of new building materials. For professionals, on the other hand, specific training is needed to further their knowledge of building techniques, use on-site, installation, and energy performance testing during the year. These informative and training activities will result in increased and more aware use of straw in construction.

In order to increase the use, even more, another line of action could be to support companies in the development of prefabricated systems and promote the engineering of site operations.

In addition, to contribute to national and international research, it would be useful to monitor several case studies on a planned and constant basis. This would provide a better understanding of material performance, expand the literature with recent data and use the results to draw up a standard and shared protocol for field measurements.

Figure 10 uses SWOT analysis to organize the main strengths, weaknesses, opportunities, and threats related to the use of straw in architecture.

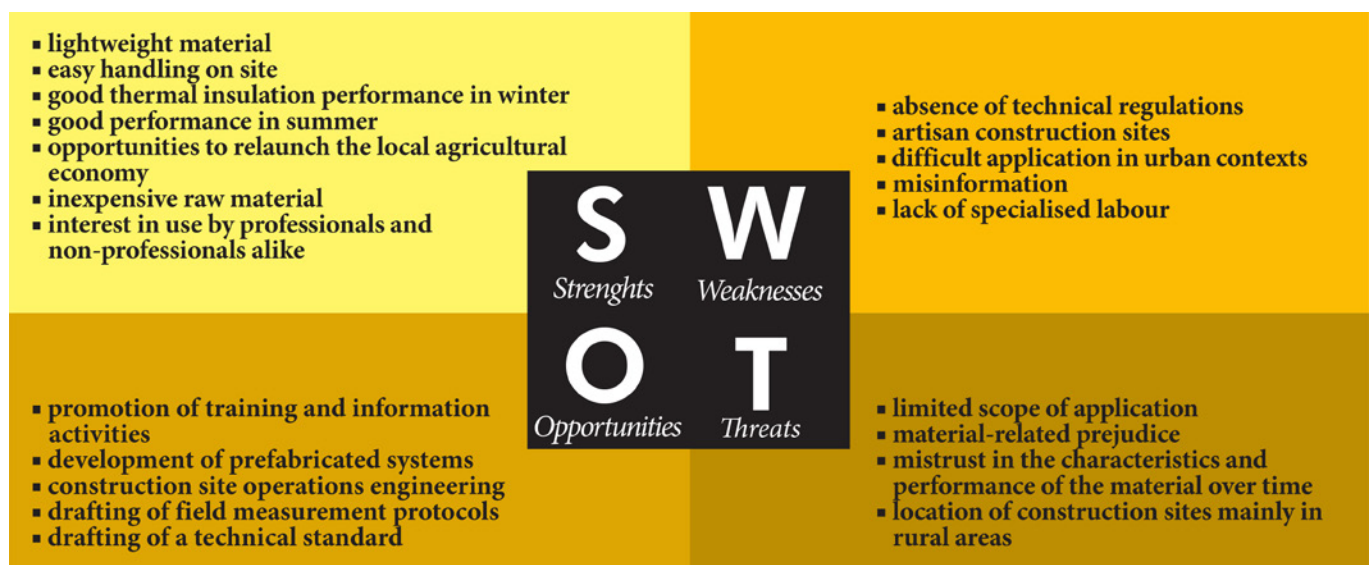

Fig. 10. SWOT analysis.

6. REFERENCES

- [1] Gaspari J (2012) Trasformare l'involucro: la strategia dell'addizione nel progetto di recupero. Edicomedizioni, Monfalcone (GO)
- [2] Ferrante A (2012) A. A. A. adeguamento, adattabilità, architettura: teorie e metodi per la riqualificazione architettonica, energetica ed ambientale del patrimonio edilizio esistente. Bruno Mondadori, Milano
- [3] Piccirillo B (2020) La paglia negli interventi di riqualificazione. Master's degree thesis in Architecture for Sustainable Design, relators: E.P. Montacchini, M.C. Azzolino, A. Lacirignola, Politecnico di Torino
- [4] Jones B (2014) Costruire con le balle di paglia: manuale pratico per la progettazione e la costruzione. Terra Nuova edizioni, Firenze
- [5] Floissac L (2012) La construction en paille. Terre vivante, Mens
- [6] Lacinski P, Bergeron M, (2000) Serious straw bale: a home construction guide for all climates. White river Junction, Chelsea
- [7] Lucchi E (2014) Riqualificazione energetica dell'involucro edilizio: diagnostica e interventi. Flaccovio, Palermo
- [8] Lanzoni D (2010) Diagnosi e certificazione energetica: prove sperimentali sugli edifici: termografia, blower door, termoflussimetro. Maggioli, Rimini
- [9] Lucchi E (2012) Diagnosi energetica strumentale degli edifici: Termografia e analisi non distruttive, Normativa e procedure operative. Flaccovio, Palermo
- [10] Mutani G, Azzolino MC, Macri M, Mancuso S, (2020) Straw Buildings: A Good Compromise between Environmental Sustainability and Energy-Economic Savings. Applied Sciences 10(8). <http://dx.doi.org/10.3390/app10082858>
- [11] FASBA (2014) Linee guida per le costruzioni in paglia
- [12] Albrecht W (2003) Wärmeleitfähigkeit nach DIN 52612. FIW, Monaco
- [13] Wimmer R et al (2000) Heat insulation performance of straw bales and straw bale walls. GrAT, Vienna
- [14] Paulsen O (2001) Thermal insulation of non plastered straw bale, on edge, flat, two different densities. Danish Technological Institute